

12CL76

8Ω**LF Drivers - 12.0 Inches**

- 700 W continuous program power capacity
- 76 mm (3 in) copper voice coil
- 45 - 3000 Hz response
- 98.5 dB sensitivity
- Ventilated voice coil gap for reduced power compression

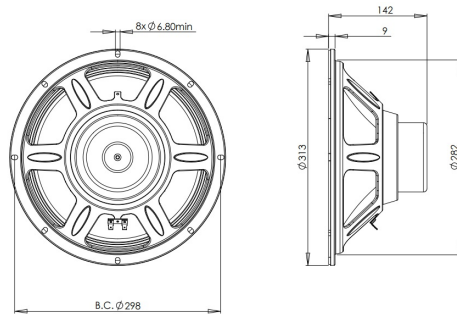

12CL76

LF Drivers- 12.0 Inches

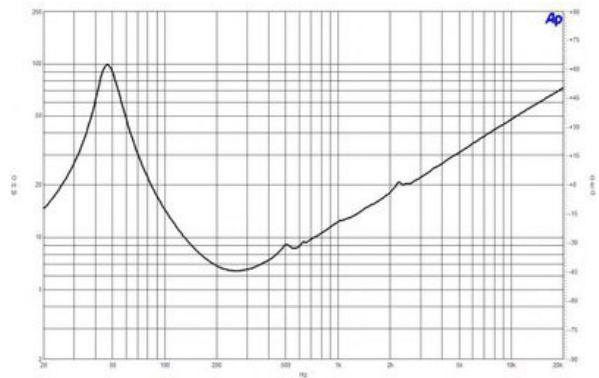
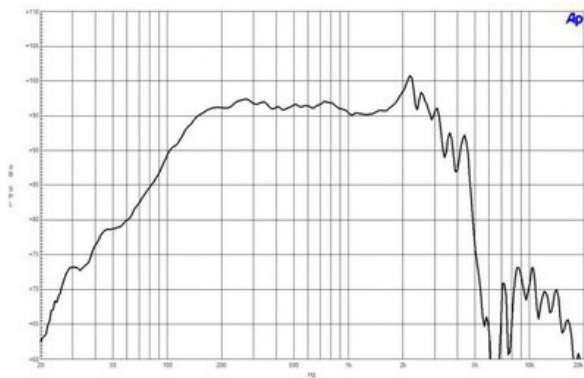

SPECIFICATIONS

Nominal Diameter	320 mm (12.0 in)
Nominal Impedance	8 Ω
Minimum Impedance	6.5 Ω
Nominal Power Handling ¹	350 W
Continuous Power Handling ²	700 W
Sensitivity ³	98.5 dB
Frequency Range	45 - 3000 Hz
Voice Coil Diameter	76 mm (3.0 in)
Winding Material	Copper
Former Material	Glass Fibre
Winding Depth	17.0 mm (0.67 in)
Magnetic Gap Depth	11.0 mm (0.43 in)
Flux Density	1.05 T

DESIGN

Surround Shape	Triple Roll
Cone Shape	Exponential
Magnet Material	Neodymium Inside Slug
Spider	Single
Pole Design	Straight Pole
Woofer Cone Treatment	WP Waterproof Front Side
Recommended Enclosure	40.0 dm ³ (1.41 ft ³)
Recommended Tuning	60 Hz

PARAMETERS⁴

Resonance Frequency	48 Hz
Re	5.2 Ω
Qes	0.22
Qms	4.8
Qts	0.21
Vas	59.0 dm ³ (2.1 ft ³)
Sd	522.0 cm ² (80.9 in ²)
η _o	2.9 %
Xmax	6.0 mm
Xvar	8.5 mm
Mms	70.0 g
Bl	22.4 Txm
Le	1.5 mH
EBP	218 Hz

MOUNTING AND SHIPPING INFO

Overall Diameter	313 mm (12.32 in)
Bolt Circle Diameter	299 mm (11.77 in)
Baffle Cutout Diameter	282.0 mm (11.1 in)
Depth	142 mm (5.59 in)
Flange and Gasket Thickness	9 mm (0.35 in)
Air Volume Occupied by Driver	2.3 dm ³ (0.08 ft ³)
Net Weight	3.0 kg (6.6 lb)
Shipping Units	1
Shipping Weight	3.9 kg (8.6 lb)
Shipping Box	360x360x200 mm (14.17x14.17x7.87 in)

SERVICE KIT

RCK12CL768

- 2 hours test made with continuous pink noise signal (6 dB crest factor) within the range Fs-10Fs. Power calculated on rated minimum impedance. Loudspeaker in free air.
- Power on Continuous Program is defined as 3 dB greater than the Nominal rating.
- Applied RMS Voltage is set to 2.83 V for 8 ohms Nominal Impedance.
- Thiele-Small parameters are measured after a high level 20 Hz sine wave preconditioning test.