

WSF081.82

Lavoce

8" WOOFER

FERRITE MAGNET
STEEL BASKET DRIVER



- 1.8 INCH COPPER VOICE COIL
- 97 dB/SPL SENSITIVITY
- 350 WATT PROGRAM POWER HANDLING
- FEM OPTIMIZED MOTOR AND SUSPENSIONS
- RESONANCE FREE AND HEAVY DUTY BASKET DESIGN

GENERAL SPECIFICATIONS

Nominal diameter	mm (in.)	200 (8)
Nominal impedance	Ω	8
Minimum impedance	Ω	6,6
Program power (1)	W	350
AES Power rating (2)	W	175
Sensitivity (3)	dB	97
Frequency range	Hz	75 ÷ 3000
Voice coil diameter	mm (in.)	45 (1.8)
Chassis material	Steel	
Magnet material	Ferrite	
Magnet dimensions OD x ID x h	mm (in.)	130 x 60 x 18 (5.1 x 2.4 x 0.7)
Coil material	Copper	
Former material	Glass fiber	
Cone material	Water Proof Treated Paper	
Surround material	Polycotton	
Xmax (4)	mm (in.)	4,6 (0.18)
Xmech (5)	mm (in.)	7,1 (0.28)
Gap height	mm (in.)	6 (0.24)
Voice coil winding height	mm (in.)	12,2 (0.48)
Driver displacement volume	l (ft ³)	0,8 (0.03)

SMALL SIGNAL PARAMETERS

DC resistance	Re	Ohm	5,6
Resonance frequency	Fs	Hz	79
Moving mass	Mms	g (oz)	19,3 (0.68)
Compliance	Cms	mm/N	0,21
Force factor	BxL	N/A	11,3
Mechanical Q-factor	Qms		2,9
Electrical Q-factor	Qes		0,43
Total Q-factor	Qts		0,37
Equivalent air volume	Vas	l (ft ³)	16 (0.57)
Voice coil Inductance	Le	mH	0,50
Diaphragm area	Sd	cm ² (in. ²)	227 (35.19)
Reference efficiency	Eta 0	%	1,80

SHIPPING INFORMATION

Net weight	kg (lb.)	2,3 (5)
Multipack size (1)	mm (in.)	260 x 260 x 137 (10.2 x 10.2 x 5.4)
Multipack weight	kg (lb.)	3 (6.6)

FREQUENCY RESPONSE

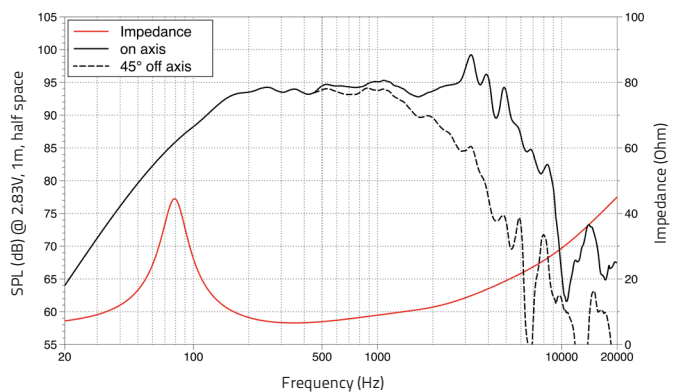

DIMENSIONS mm (in.)

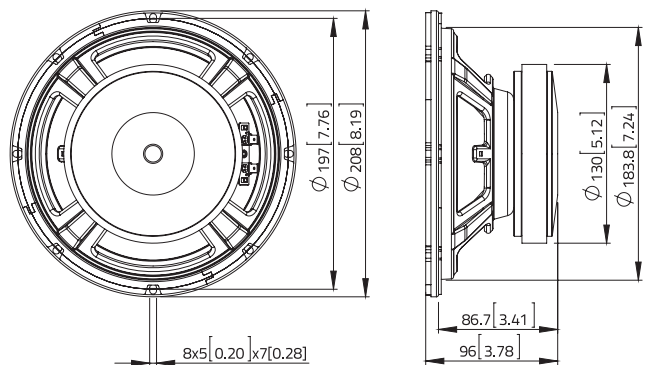

(1) Program power is defined as 3 dB greater than AES Power. (2) Tested for two hours using a continuous, band-limited pink noise signal as per AES 2-1984 Rev. 2003. Loudspeaker tested in free air. (3) From T/S parameters, measured with Klippel DA LPM module. (4) The Xmax is calculated as: $(Hvc - Hg)/2 + Hg/4$. Hvc is the voice coil height and Hg the gap height. (5) The Xmech is calculated as: $(Hvc - Hg)/2 + (Hg - 2)$. Hvc is the voice coil height and Hg the gap height. (6) Thiele-Small parameters are measured after preconditioning: a) at 20°C - 22°C, 50% humidity for 2 hours; b) by Klippel LSI measurement.

All specifications subject to change without notice_B.a

